

Wiser™ for C-Bus® Automation Controller

Quick Start Guide

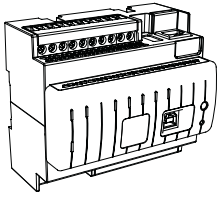

Wiser for C-Bus® Automation Controller
5500SHAC

Getting to know the Controller

The Wiser for C-Bus® Automation Controller controls and manages C-Bus systems for residential buildings and integrates additional systems to achieve a customised solution and an environment of comfort, convenience, security, and energy efficiency. The Wiser for C-Bus® Automation Controller is referred to in the following as **Controller**.

From simple control to advanced installations, C-Bus provides control and automation of lighting, blinds and shutters and room occupancy.

The integrated visualisation allows local or remote control via PC, tablet, touch panel or smart phone. This includes scene functions, scheduling, trend logging and control.

Logic scripts can be programmed into the device to achieve complex control and advanced management functions.

The integration of IP cameras, web services and additional building management functions (e.g. BACnet and MODBUS) is possible via Ethernet.

Interaction with other equipment and systems is possible via I/O connections including RS-232, RS-485 (MODBUS RTU), digital input (optional monitored input), SELV relay output and LED driver output.

The communication with MODBUS allows the integration of energy metering and climate control with C-Bus.

The product can be accessed over Ethernet for configuration and visualisation via the web server function.

Local access for configuration with a laptop is provided by the USB Type B adaptor.

A USB Type A connector for USB host (USB 2.0 High Speed) provides connection to USB expansion devices.

8 LEDs on the front panel provide full status feedback.

2 Reset buttons permit software and hardware reset functionality.

The product needs an external power supply (24 V DC).

The Controller is designed for a maximum of:

- Objects (C-Bus and internal): *2000
- Users for visualisation: 8
- MODBUS devices: 6
- BACnet data points: 50

* Limits not physical but dependant on maximum CPU load.

For your Safety

⚠ DANGER

HAZARD OF ELECTRIC SHOCK, EXPLOSION, OR ARC FLASH

- It is illegal for persons other than an appropriately licensed electrical contractors or other persons authorised by legislation to work on the fixed wiring of any electrical installation.
- To comply with all safety standards, the product must be used only for the purpose described in this instruction and must be installed in accordance with the wiring rules and regulation in the location where it is installed.
- There are no user serviceable parts inside the product.

Failure to follow these instructions will result in death or serious injury.

⚠ CAUTION

EQUIPMENT DAMAGE HAZARD

Install the device according to instructions in this document.

- Pay attention to the specifications and wiring diagrams related to the installation.
- Do not use this product for any other purpose than specified in this instruction.

Failure to follow these instructions can result in minor injuries, or equipment damage.

Mounting/Removing the Controller

Mounting

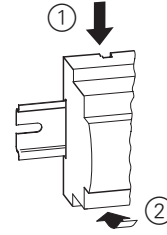

Removing

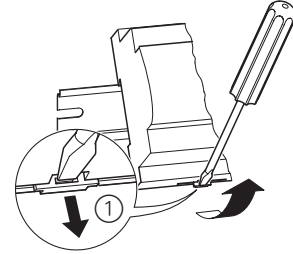

Connections

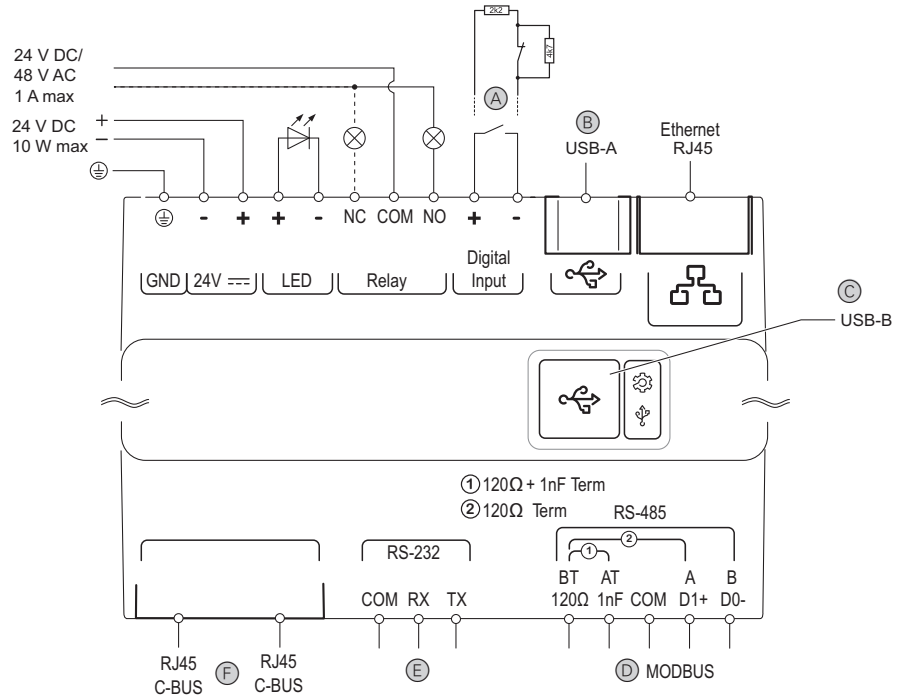

(A) Digital Input	• Compatible with either a potential-free contact or a monitored cable using End of Line Resistance									
(B) USB-A	• USB Type A connector for USB Host	USB 1.1 and USB 2.0 devices are supported								
(C) USB-B	• USB Type B connector for USB programming Port	USB 1.1 full speed is supported								
(D) RS-485	• MODBUS • Shield must be connected to earth at end of line • Line must be terminated at each end	D1+ and D0- = twisted wires Incorporates 47kΩ polarisation resistors Optional in-built low power terminator of 120 Ω + 1 nF = link AT-BT Optional in-built legacy terminator of 120 Ω = link BT-A								
(E) RS-232		Tx = Transmit Rx = Receive COM = Common								
(F) C-Bus	• 2 C-Bus Connectors with RJ pins	<table border="0"> <tr> <td>Pin 1 Remote ON</td> <td>Pin 5 C-Bus Neg (-)</td> </tr> <tr> <td>Pin 2 Remote ON</td> <td>Pin 6 C-Bus Pos (+)</td> </tr> <tr> <td>Pin 3 C-Bus Neg (-)</td> <td>Pin 7 Remote OFF</td> </tr> <tr> <td>Pin 4 C-Bus Pos (+)</td> <td>Pin 8 Remote OFF</td> </tr> </table>	Pin 1 Remote ON	Pin 5 C-Bus Neg (-)	Pin 2 Remote ON	Pin 6 C-Bus Pos (+)	Pin 3 C-Bus Neg (-)	Pin 7 Remote OFF	Pin 4 C-Bus Pos (+)	Pin 8 Remote OFF
Pin 1 Remote ON	Pin 5 C-Bus Neg (-)									
Pin 2 Remote ON	Pin 6 C-Bus Pos (+)									
Pin 3 C-Bus Neg (-)	Pin 7 Remote OFF									
Pin 4 C-Bus Pos (+)	Pin 8 Remote OFF									

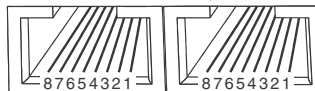

- To use RJ 45 with C-Bus Cat-5 network cable

Displays and Operating Elements

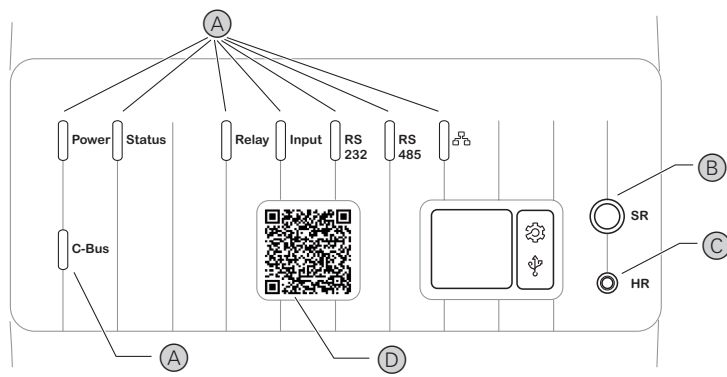

- Ⓐ Status feedback LEDs
- Ⓑ Software Reset button
- Ⓒ Hardware Reset button
- Ⓓ QR code with information about this specific unit for use with the Facility Hero App (available from iTunes™ and Google Play™)

Meaning of the Status Feedback LEDs

LEDs	Cause		
Power	Green, blinking Red	Controller is running with blink rate proportional to processor load	
	Green	Controller is powered but has been shut down	
	Red	Problem with processor board or power supply	
	Off	Controller has no power	
Status	Green	Controller is running properly	
	Red flashing	During factory reset	
	Red	During software reset	
	Off	During boot up	
Relay	Green	Relay is On	
	Off	Relay is Off	
Digital Input	Monitored input		
	Green	Input in high resistance (6.9 kΩ) - switch open state	Potential free contact (switch/relay)
	Yellow	Open circuit (> 12 kΩ)	Input is open circuit
	Red	Short circuit (< 1 kΩ)	Input is closed circuit
	Off	Input in low resistance (2.2 kΩ) - switch closed state	
RS232	Green	Controller is transmitting	
	Magenta	Controller is receiving	
	White	Controller is receiving and transmitting	
	Off	No communication	
RS485	Green	Controller is transmitting	
	Magenta	Controller is receiving	
	White	Controller is receiving and transmitting	
	Off	No communication	
Ethernet	Green	Ethernet is operating (100 Mbit/s)	
	Yellow	Ethernet is operating (10 Mbit/s)	
	Blinking	Data traffic	
C-Bus	Green	C-Bus powered and clock active	
	Flashing	C-Bus low voltage warning	
	Off	No C-Bus power or no active clock	

How to Reset

Software Reset

Shutdown and Reset

- Forces running processes to stop and reboots after

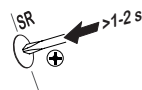

Factory Reset

- Recover your system to its original factory condition

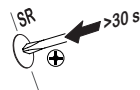

Hardware Reset

Processor Reboot

- Power turned off and back on again
- Wake up signal for a unit that has been shut down



Configuration

Access to the web server of the Controller

- Default user name: admin
- Default password: admin

Access via Ethernet:

- The Controller must be supplied with 24 V DC
 - The default IP address is 192.168.0.10
- Connect Ethernet cable with PC.
 - Use on the PC e.g. address 192.168.0.9 and subnet mask 255.255.255.0.
 - Run Google Chrome™ or Firefox® and go to 192.168.0.10.

Access via USB-B:

- The controller may be powered by USB for configuration purposes.
 - The IP address is 192.168.254.10.
 - The USB drivers are included with the latest C-Bus Toolkit installation.
- Connect USB-B with a USB port of the PC. The PC is given a DHCP IP address in the range of 192.168.254.1 – 192.168.254.9.
 - Run Google Chrome™ or Firefox® and go to 192.168.254.10.

With the C-Bus Toolkit you can configure, export and import a C-Bus project.

It is recommended to update the firmware to install the latest features, security updates and bug fixes. Scan the QR code using the Facility Hero App for information specific to your device.

Technical Data

Power Supply:	24 V DC +/- 5 % 10 W max 2 W typical
C-Bus Power:	15-36 V DC, 32 mA
Operating elements:	Software Reset button Hardware Reset button
Display elements:	8 Status Feedback LEDs Power, Status, Relay, Digital Input, RS232, RS485, Ethernet, C-Bus
External Interfaces:	
Power supply	24 V DC plus separate GND
LED Output Driver	40 mA current limited
Relay Output	NO, NC, Common 48 V AC / 24 V DC 1 A max
Digital Input	Potential-free contact or Monitored input impedances of 2.2 kΩ closed, and 6.9 kΩ open.
USB-A	Type A USB 2.0 high speed host
USB-B	Type B USB 1.1 full speed device, for configuration
Ethernet	RJ45 for 10/100 BASE-T UTP Ethernet
RS-485, MODBUS	120 Ω Terminator, 1 nF Terminator, Common, A D1+, B D0-
RS-232	Receive, Transmit, Common
C-Bus	2x RJ45
Terminals	18x screw terminals 1.5 mm ² single-core and multi-core
Dimensions (WxHxD):	108 x 63 x 93 mm
Mounting method:	DIN Rail, clips
External conditions:	
Ambient temperature during operation	-5 °C to +45 °C
Ambient temperature during storage	-20 °C to +80 °C
Rel. humidity (not condensing)	10 % to 93 %
Type of protection	IP 20
Radiated Emissions:	EN 55022 / AS/NZS CISPR 22 Class A

Warning: This is a Class A product. In a domestic environment this product may cause radio interference in which case the user may be required to take adequate measures.

Product Compliance:



Warranty

Schneider Electric (Australia) Pty Ltd, (Clipsal by Schneider Electric), warrants this product to be free from defects in materials and workmanship for a period of two years from the date of installation. The benefits conferred herein are in addition to any other rights and remedies you may have at law in respect to this product.

Australian Consumer Law specifies that our goods come with guarantees that cannot be excluded. You are entitled to a replacement or refund for a major failure and compensation for any other reasonably foreseeable loss or damage. You are also entitled to have the goods repaired or replaced if the goods fail to be of acceptable quality and the failure does not amount to a major failure.

Schneider Electric (Australia) Pty Ltd

Customer Care Australia:
Phone: 1300 369 233
Email: customercare.au@schneider-electric.com
www.clipsal.com
www.schneider-electric.com.au

Schneider Electric (New Zealand) Ltd

Schneider Electric (NZ) Ltd
38 Business Parade South
East Tamaki 2013
Auckland
New Zealand

Customer Care New Zealand:
Phone: 0800 652 999
Email: sales@nz-schneider-electric.com